



Local Farmers Markets Open



**ASH CREEK
ARTS CENTER**
INVESTIGATE • EDUCATE • CREATE

HOWL from the HEART



GIVING DAY
APRIL 7, 2026
Western Oregon
UNIVERSITY



A FUNDRAISER TO SUPPORT THE
HERITAGE MUSEUM SOCIETY

ODDITIES AUCTION



TRI-TIP
Thursday

Community Calendar April 2026

Addresses for events are generally in Monmouth (M) or Independence (I)

Wednesday, April 1, April Fools' Day

Ongoing: Art Exhibit, "Still They Speak" paintings, at Cannon Gallery, WOU

Great Western Music Championships Concerts, all day, Rice Auditorium (M)

Office hours, Indep. Mayor Kate Schwarzler, 8:30-10:30 AM, 555 Main St (I)

Storytime, 10:30 AM, Independence Library (I)

Kids Coding, 4 PM, Independence Library (I)

Something Rotten!, 7:30 PM, Pentacle Theatre, West Salem

Thursday, April 2, International Children's Book Day

Great Western Music Championships Concerts, all day, Rice Auditorium (M)

CHS Boys Tennis, Central Dual TBN Meet, time TBD, at CHS Serving Prime Rib, Golden Hop Saloon, 133 C St (I)

Independence Downtown Association meets, 8 AM, K Insurance Group, Central Plaza (I)

Age Café, 10 AM, Monmouth Sr. Comm. Center (M)

Friends/Library bookstore open, 10AM- 2 PM, Ind. Library (I)

Bounces & Rhymes, 10:30 AM, Monmouth Public Library (M)

CHS Baseball vs La Salle Prep, 5 PM, at CHS

Independence Downtown Association's Quarterly Meeting, 5:30 PM, Independence Hotel (I)

Family Feud, 7 PM, Rookies Sports Tap (M)

Something Rotten!, 7:30 PM, Pentacle Theatre, West Salem

Friday, April 3, Good Friday

Great Western Music Championships Concerts, all day, Rice Auditorium (M)

Serving Tri Tip, Golden Hop Saloon, 133 C St (I)

WOU Baseball vs Northwest Nazarene University, 1 & 4 PM, at WOU (M)

WOU Softball vs Montana State University Billings, 1 & 3 PM, at WOU (M)

Something Rotten!, 7:30 PM, Pentacle Theatre, West Salem

Saturday, April 4, NATO was created, 1949

Breakfast served, 8:30 AM, Monmouth Sr. Comm. Center (M)

Farmers Markets Open in Indy, 9 AM-2 PM. Downtown (I)

Book Sale by Friends of the Independence Library, 10 AM – 3 PM, Old Library (I)

Oregon Lions Blooms & Brunch Gala, 11 AM-2:30 PM, Portland Art Museum

Brunch served, 11 AM – 2 PM, Golden Hop Saloon, 133 C St (I)

WOU Baseball vs Northwest Nazarene University, 12 PM, at WOU (M)

WOU Softball vs Montana State Univ., 12 PM, at WOU (M)

Bingo at the Elks Lodge, 1 PM, 289 S Main St (I)

Something Rotten!, 2:00 PM, Pentacle Theatre, West Salem

Something Rotten!, 7:30 PM, Pentacle Theatre, West Salem

Sunday, April 5, Easter Sunday

Polk County Flea Market, 6am (early bird), 9am (general admission), Polk County Fairgrounds, Rickreall

Brunch served, 11 AM – 2 PM, Golden Hop Saloon (I)

Something Rotten!, 2:00 PM, Pentacle Theatre, West Salem

Monday, April 6, National Tartan Day

Monday BOGO 50% Burgers, Golden Hop Saloon, 133 C St (I)

WOU Mariachi los Lobos del Poniente, 7 PM, Smith Recital Hall WOU (M)

Tuesday, April 7, World Health Day

HOWL FROM THE HEART Giving Day at WOU

Happy Hour all day, Golden Hop Saloon, 133 C St (I)

Taco Tuesday at Rookies Sports Tap, Monmouth

Monmouth Business Assn. meets, 8 AM, City Hall (M)

Veteran's Chat, 10-11 AM, Heron Pointe Sr. Living (M)

Family Story Time, 10:30 AM, Monmouth Library (M)

Age Café, 10 AM, Monmouth Senior Community Center (M)

Kids Coding, 4 PM, Independence Library (I)

CHS Girls Tennis, South Albany, Kings Valley Charter Dual GTN Meet, 4 PM, at CHS

CHS Baseball vs McNary, 5 PM, at CHS

Monmouth City Council meets, 6:30 PM, 151 Main St W (M)

Tues. Night Adult Class, 6:30-8:30 PM, Ash Creek Arts Ctr (I)

Wednesday, April 8, National Zoo Lovers Day

WOU Wednesday!

PreK Art Adventures, 10 AM, Ash Creek Arts Center (I)

Office hours, Indep. Mayor Kate Schwarzler, 8:30-10:30 AM, 555 Main St (I)

Storytime, 10:30 AM, Independence Library (I)

WOU Baseball vs George Fox University, 3 PM, at WOU

Music Jam Night, 6 PM, Monmouth Sr. Community Ctr (M)

Something Rotten!, 7:30 PM, Pentacle Theatre, West Salem

Thursday, April 9, Lee surrendered to Grant, 1876

Serving Prime Rib, Golden Hop Saloon, 133 C St (I)

Age Café, 10 AM, Monmouth Senior Community Center (M)

Bounces & Rhymes, 10:30 AM, Monmouth Public Library (M)

Friends/Library bookstore open, 10AM- 2 PM, Old Library (I)

CHS Girls Tennis, McKay Dual BTN Meet, 4 PM, at CHS

Teen & Adul Lacy Bowl Art, 4 PM, Independence Library (I)

Tri-Tip Thursday at Brew Coffee & Tap House, 5:30-7:30 PM, at Brew (I)

Yes! You Can Grow Olive Trees in Oregon, Heritage Museum Speaker Series, 6 PM, Valkyrie Wine Tavern (I)

Family Feud, 7 PM, Rookies Sports Tap, Monmouth

Climate Café, 7-8:30 PM, Monmouth Senior Center (M)

Something Rotten!, 7:30 PM, Pentacle Theatre, West Salem

Friday, April 10, National Bookmobile Day

WOU Track & Field, John Knight Twilight

Serving Tri Tip, Golden Hop Saloon, 133 C St (I)

WOU Baseball vs Centr. WA Univ., Ellensburg, 12 PM, at WOU

Taiko Drum Workshop ages 6-8, 1 PM, Monmouth Library (M)

Taiko Drum Workshop ages 9-18, 1:45 PM, Mon. Library (M)

Something Rotten!, 7:30 PM, Pentacle Theatre, West Salem

Saturday, April 11, National Pet Day

PICK UP DAY for M-I Green Bag Project/Food Bank

WOU Track & Field, John Knight Twilight

Farmers Markets Open in Indy, 9 AM-2 PM, Downtown

Community Calendar April 2026

"Drawing" Youth Class, 10 AM-12 PM, Ash Creek Arts Ctr (I)
Brunch served, 11 AM – 2 PM, Golden Hop Saloon (I)
Veteran/Month, 1 PM, Heritage Museum & Park (I), if held
Bingo at the Elks Lodge, 1 PM, 289 S Main St (I)
A Night in New York Daddy/Daughter Dance, 4-7 PM, YMCA,
685 Court St NE, Salem

Something Rotten!, 7:30 PM, Pentacle Theatre, West Salem

Sunday, April 12, International Day of Human Space Flight
Brunch served, 11 AM – 2 PM, Golden Hop Saloon (I)

Monday, April 13, 1970, the emergency on Apollo 13...

CHS Baseball vs Woodburn, 5 PM, at CHS

CHS Softball vs Lebanon, 5 PM, at CHS

Tuesday, April 14, National Gardening Day

Imagine Our Future Showcase, April 14-29 at Monmouth
Senior Community Center (M)

Family Story Time, 10:30 AM, Monmouth Library (M)

Google Docs, 1-2:30 PM, Monmouth Library (M)

Minion Madness Party, 4 PM, Independence Library (I)

Girls Tennis, Woodburn Dual BTN Meet, 4 PM, at CHS

Independence City Council meets, 6:30 PM, City Hall (I)

Wednesday, April 15, Tax Day

Office hrs, Indep Mayor Kate Schwarzler, 8:30-10:30 AM (I)

PreK Art Adventures, 10 AM, Ash Creek Arts Center (I)

Storytime, 10:30 AM, Independence Library (I)

Kids Coding, 4 PM, Independence Library (I)

CHS Softball vs Tillamook, 5 PM, at CHS (I)

Ukulele Jan Night, 6 PM, Monmouth Senior Center (M)

Adaptive Arts Guild (ages 9-15), 6-7:30 PM, Ash Cr. Arts Ctr (I)

Thursday, April 16, National Librarian Day

Taco Tuesday at Rookies Sports Tap, Monmouth

Bounces & Rhymes, 10:30 AM, Monmouth Public Library (M)

Thursday Adult Art Class (16+), 6:30-8:30 PM, Ash Creek Arts
Center (I)

Friday, April 17, Daffy Duck's Birthday

WOU Baseball vs Montana St Univ, Billings, 1 & 4 PM, WOU

CHS Baseball vs South Albany, 5 PM, at CHS

CHS Softball vs Lebanon, 5 PM, at CHS

Saturday, April 18, National Pinata Day

Farmers Markets Open in Indy, 9 AM-2 PM Downtown

Rotary's 21st annual Community Baby Shower, 10 AM-12 PM,
Salem

Community Craft Days, 10 AM-4 PM, Mon. Sr. Comm. Ctr.
(M)

CHS Boys & Girls Track & Field John Oliver Invitational, 10:30
AM, at CHS

Backyard Wildlife, 11 AM, Monmouth Library (M)

Bingo at the Elks Lodge, 1 PM, 289 S Main St (I)

WOU Softball vs Saint Martin's University, 1 & 3 PM, at WOU

WOU Baseball vs Montana St. Univ Billings, 1 & 4 PM, at
WOU

**Sunday, April 19, The Shot Heard Round the World (start of
American Revolution), 1775**

Community Craft Day, 10 AM-4 PM, Mon. Sr. Comm. Ctr. (M)

WOU Softball vs St Martin's University, 12 & 2 PM, at WOU

Let's Draw at the Gallery, 1 PM, River Gallery (I)

Oddities Auction, 3 PM, Valkyrie Wine Tavern (I)

Monday, April 20, Volunteer Recognition Day

CHS Baseball vs Silverton, 5 PM, at CHS

Tuesday, April 21, Big Word Day

Family Story Time, 10:30 AM, Monmouth Library (M)

Mystery Book Club, 4 PM, Independence Library (I)

CHS Girls Tennis Silverton Dual BTN Meet, 4 PM, at CHS

Monmouth City Council meets, 6:30 PM, 151 Main St W (M)

Wednesday, April 22, Earth Day

Last day to submit information to 2C1C for May edition

Office hours, Indep Mayor Kate Schwarzler, 8:30-10:30 AM(I)

PreK Art Adventures, 10 AM, Ash Creek Arts Center (I)

Storytime, 10:30 AM, Independence Library (I)

Kids Coding, 4 PM, Independence Library (I)

Imagine Our Future Showcase, 6-8 PM, Mon Sr Comm Ctr (M)

Adult Drawing Class, Ages 16+, 6:30-8:30 PM, Ash Creek Arts
Center (I)

Thursday, April 23, William Shakespeare's Birthday, 1564

Launch Mid-Valley Coffee Club, 9 AM, Indy Commons (I)

Friends/Library bookstore open, 10AM- 2 PM, Old Library (I)

Bounces & Rhymes, 10:30 AM, Monmouth Public Library (M)

Family Coloring Club, 4 PM, Independence Library (I)

CHS Boys Tennis, central Dual TBN Meet, 4 PM, at CHS

Tri-Tip Thursday at Brew Coffee & Tap House, 5:30-7:30 PM,
at Brew (I)

Friday, April 24, The Library of Congress established, 1800

Saturday, April 25, World Puppetry Day

Farmers Markets Open in Indy, 9 AM-2 PM, Downtown (I)

Polk County Fam Jam, 10 AM-2 PM, Polk County Fairgrounds

Saturday Adult Art Workshop (16+), 10 AM-3 PM, Ash Creek
Arts Center (I)

Bingo at the Elks Lodge, 1 PM, 289 S Main St (I)

Sunday, April 26, The Chernobyl meltdown occurred in 1986

CelloBop, 1-2 PM, Monmouth Library (M)

Watercolor Paint 'n Sip, 2-4 PM, Hazel's on Main (M)

Monday, April 27, Freedom Day

CHS Baseball vs Crescent Valley/Kings Valley Charter, 5 PM,
at CHS

**Tuesday, April 28, The Mutiny on the Bounty occurred in
1789**

Family Story Time, 10:30 AM, Monmouth Library (M)

Chair Yoga with Winnie, 11 AM, Independence Library (I)

Independence City Council meets, 6:30 PM, City Hall (I)

Wednesday, April 29, "Hair" opened on Broadway in 1968

Craft with a Cop, 1:30 PM, Monmouth Library (M)

Thursday, April 30, Louisiana Purchase Complete (1803)

Bounces & Rhymes, 10:30 AM, Monmouth Library (M)

Storytime, 10:30 AM, Independence Library (I)

Kids Coding, 4 PM, Independence Library (I)

CHS Girls Tennis, Central Dual BTN Meet, 4 PM, at CHS

Quarterly Town Hall, 5:30-7 PM, Monmouth City Hall (M)

WHAT WOU GIVING DAY FUNDS:

- | | |
|-------------------------|------------------------|
| Abby's House | Math Club |
| Art Scholarship | Model UN |
| ASL Club | Monmouth Student |
| Aspiring Teachers | Nursing |
| Association | MSSP |
| ASWOU | National Student |
| Athletics | Exchange |
| Biology | Native/Indigenous |
| Choir | Culture Club |
| Class of 2025 Gift | Natural Sciences Club |
| Club Sports | Occupational Therapy |
| College of Education | Phi Alpha Theta |
| Dean's Fund | Scholarships |
| College of Liberal Arts | Seabeck DeafBlind |
| Dean's Fund | Academic |
| Degree Completion | Smith Fine Arts Series |
| Grant | Staff for Students |
| Earth Science | Scholarship |
| Academic Fund | Student Engagement |
| Emergency Student Aid | Student Enrichment |
| Fund | Program |
| Emeritus Society | Student Enrichment |
| Scholarship | Program |
| Family Weekend Fund | Student Media |
| Filipino American | Student Success |
| Association | Center |
| First Generation Fund | Student Veterans of |
| Freedom Center | America |
| Future Wolves | Tree Campus |
| German Program & | Triangle Alliance |
| Club | Unidos |
| Graduate College | Wolf Pride Network |
| Dean's Fund | Wolves Supporting |
| Hamersly Library | Veterans |
| Hawai'i Club | WOU Food Pantry |
| LGBTQIA+ Scholarship | Write Place |



YOU ARE KEY TO UNLOCKING THE BIG GIFT!

ON APRIL 7, 2026, WESTERN OREGON UNIVERSITY INVITES YOU TO FUND YOUR PASSION!

WE NEED 500 GIFTS ON GIVING DAY TO UNLOCK A SPECIAL \$25,000 BIG GIFT. WILL YOURS BE ONE OF THEM?

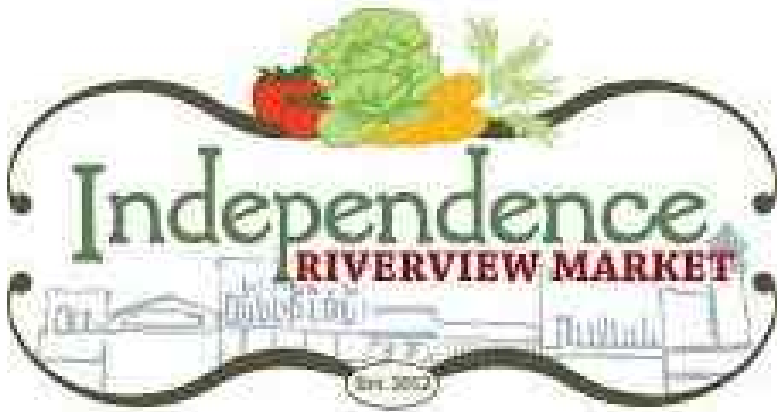

Saturdays, 9 AM to 2 PM, April through October at the Top of Riverview Park

You can use your **Polk County Community E-Gift Card** at a **variety of retail, restaurant, service, and entertainment locations**, making it easy and convenient to use the same gift card at multiple locations.



The Thoughts & Gifts Project

FREE
personalized birthday gifts up to \$40,
books, cards, & more!

- Youth • I/DD individuals • Senior citizens

Must live in Polk County and qualify for federal assistance



Tax ID #82-3488166



- 🌐 thoughtsandgifts.org
- 📧 info@thoughtsandgifts.org
- 📱 [@thoughtsandgifts](https://www.facebook.com/thoughtsandgifts)
- 🕒 Open Tuesday - Friday | 1PM - 5PM
- 📍 427 Main Street E, Monmouth
- ☎ 971-289-6358

celebrating birthdays, celebrating you

• Saturdays-9am-2pm •
• April-November •

THE ORIGINAL
**INDEPENDENCE
FARMERS
MARKET**
SINCE 1993

📍 Umpqua Bank Parking Lot
302 S. Main St.
Independence, OR



MINET FIBER

Monmouth Independence Network

THE POWER OF LOCAL

503 837-0700,

www.minetfiber.com

405 Hogan Rd N, Monmouth

A FUNDRAISER TO SUPPORT THE
HERITAGE MUSEUM SOCIETY

ODDITIES AUCTION



AUCTION IS
APRIL 19TH @ 3PM
VALKYRIE WINE TAVERN

SEEKING DONATIONS!
WE NEED YOUR STRANGE AND UNUSUAL ITEMS!

- ODDITIES • CURIOSITIES • COLLECTIBLES
- BIZARRE RELICS • FUN & INTERESTING

CONTACT US TO DONATE!

TO LEARN MORE, CONTACT HMS
PRESIDENT MARILYN MORTON
MARILYN97351@GMAIL.COM

OR THE HERITAGE MUSEUM
ORHERITAGE@CI.INDEPENDENCE.OR.US



CELEBRATING 20 YEARS AS YOUR LOCAL INTERNET PROVIDER

Thank you for trusting MINET Fiber since 2006



MINET FIBER



ADOPT-AN-ARTIFACT

Celebrating 50 Years of Preserving History

The Adopt an Artifact program is a simple and meaningful way to care for the objects that tell Independence's story. By supporting a specific artifact, you help fund its conservation and care, strengthen the Museum's ability to serve the community, and deepen the connection between the past and present. Launched as part of the Museum's 50th anniversary, this program is both a celebration of how far we've come and an invitation to help carry our history forward for the next 50 years.



How It Works



- Choose an artifact to "adopt" from a curated list selected by museum staff -OR-
- Choose an adoption level meaningful to you and museum staff will select the artifact for you
- Receive a certificate of adoption, recognition in the museum newsletter, and a report on the condition of the artifact at the end of 2026.

Adoptions are symbolic and do not transfer ownership of the artifact. Your contribution is tax deductible

Adoption Levels



- \$25 - Caretaker (Provide Archival Materials)
- \$50 - Preserver (Cleaning & Digital Cataloging)
- \$100 - Conservator (Custom Housing or Mount)
- \$250 - Steward (Specialized Preservation)

Adoption funds are directed to the Heritage Museum Society and support the ongoing care, preservation, and interpretation of the museum's collections

Please Donate to the Oddities Auction! Do you have something a bit quirky, unusual, or odd? Donate it to the Oddities Auction, a benefit for the Heritage Museum. Drop off your oddities at the museum. We'll send you a receipt.

AND, consider coming to the auction on April 19!



SPONSORED BY THE HERITAGE MUSEUM SOCIETY

Monmouth Monthly:
ci.monmouth.or.us

**Subscribe
to these
monthly
newsletters**

River City Briefs:
ci.independence.or.us



River City Briefs



INDEPENDENCE
Oregon's Story Begins Here

Find out
what's
Happening
in our communities!

April 2026 Spectrum Artworx

SUNDAY 1PM-7PM	MONDAY 11AM-7PM	TUESDAY 11AM-7PM	WEDNESDAY 11 AM-7PM	THURSDAY CLOSED	FRIDAY 11AM-7PM	SATURDAY 11AM-7PM
			WOU Wednesday 1	Closed 2	3	Misha Pierce Beginner Lettering 4pm-6pm \$35 4
5	Beginner PanPastel 11am-12:30pm \$30 6	Beginner MiniFigure Painting 8:30pm-9:30pm \$55 7	WOU Wednesday Beginner PanPastel 4pm-5:30pm \$30 8	Closed 9	10	11
Drop in Cardmaking 2pm-4pm \$5 per card 12	Epoxy Resin Casting 4pm-7pm \$15 + Materials 13	Senior Center Event 1pm-3pm 14	WOU Wednesday Adults Dungeons and Dragons Group 1B + 5pm-8pm Suggested \$15 15	Closed 16	17	Misha Pierce Nature Drawing 4pm-6pm \$35 18
19	Beginner PanPastel 11am-1:30pm \$30 20	Senior Center Event 11am-1pm 21	WOU Wednesday Beginner PanPastel 4pm-5:30pm \$30 22	Closed 23	24	25
15+ Dungeons and Dragons 2pm-5pm Suggested \$5 26	Epoxy Resin Casting 4pm-7pm \$15+Materials 27	28	WOU Wednesday 29	Closed 30		

Retail 140 Main Street West Monmouth Oregon

Phone # (503)-837-0931

Classroom 150 Main Street East Monmouth Oregon

Website: Spectrumartworx.com

ABOUT 2C1C, Two Cities, One Community:

- 2C1C has a standing policy of giving free advertising to local businesses! These ads are generally sized from to 1/3 to 1/4 page. Smaller print will be accommodated or edited for space and clarity.
- Deadline for submissions is the 25th of the month.
- This online magazine is ready to publish by the 1st of each month.
- If you have questions, please let us know by texting 2C1C at 503 580-8525, or email marilyn97351@gmail.com

If you have an **event** or **advertisement** to be featured in a future edition of 2C1C, please send your information to the one of the contacts shown above. As noted, information and/or ad copy is needed by or before the 25th of the month for inclusion in the following month's issue.

2C1C, Two Cities, One Community, has been a regular monthly publication since May, 2012. Editor: Marilyn Morton

CLIMATE CAFÉS



JAN 8

FEB 12

MAR 12

APR 9

The Monmouth-Independence Climate Group will host an open exploration of personal emotions around climate anxiety in a supportive, "Café-Style" setting. Please join us to listen and share the often complex feelings and concerns about this pressing issue. People of all ages are invited to attend.

7:00 - 8:30pm each evening

Monmouth Senior Community Center
180 Warren Street S.
503-838-5678



Monmouth-Independence
Climate Group

ARTISTS & WRITERS:

what does a positive, sustainable future look like?

JANUARY 20 ^{7PM}

Kickoff Gathering

Join other artists and writers and spark ideas for your submission
Spectrum Artworx in Monmouth

MARCH 1 - 31

Art & Writing Submissions

Find submission rules and in-person drop-off information at:
<http://bit.ly/imagine-our-future>

APRIL 14 - 29 ^{9AM-4PM} Weddays

Showcase

See the community's visions of the future
Monmouth Senior Community Center

APRIL 22 ^{6-8PM}

Reception

IMAGINE OUR FUTURE

a local showcase with prizes for all ages
<http://bit.ly/imagine-our-future>



April 6 is National Tartan Day. Here is the officially registered "Oregon Tartan".

The logo affiliated with this official tartan is: "Alis volat propriis" (She flies with her own wings)



Blooms & Brunch GALA

April 4, 2026 | 11:00 am - 2:30 pm
PORTLAND ART MUSEUM
Kridel Ballroom

TERRITORY

Explore. Savor. Sip.

SALADS

WINTER TERRITORY	15
spring mix & spinach, diced pears, blue cheese, candied pecans, bacon, with apple cider vinaigrette.	
CAESAR	15
romaine lettuce, parmesan cheese, house made croutons, and caesar dressing	

HOUSE SALAD	8
spring mix, carrots, cucumbers with a choice of dressing.	
dressing choices: ranch, blue cheese, caesar, lemon vinaigrette, balsamic vinaigrette, apple cider vinaigrette	

STARTERS

SPINACH ARTICHOKE DIP	16
spinach, jalapeño, and artichoke dip topped with parmesan cheese, baked and served with toasted naan	
CHICKEN WINGS	16
1lb of wings with your choice of buffalo, teriyaki, or a rotating sauce	
SHRIMP SCAMPI	18
sautéed shrimp served in a rich white wine and garlic butter sauce	
ADD PASTA	7
CHARCUTERIE PLATE	17
artisan meats and cheeses, nuts, dried fruits, gherkins, pepperoncinis, and house made crostini	
STEAK TIPS	18
6oz sirloin steak tips in a garlic and bourbon cream sauce	
CAPRESE FLATBREAD	14
toasted garlic naan, cherry tomatoes, mozzarella, basil, topped with a balsamic glaze	
TERRITORY SPROUTS	12
Brussel sprouts covered in parmesan cheese, bacon, capers, and lemon vinaigrette	
HOUSE FRENCH FRIES	8
add fresh garlic or rosemary parmesan	

ADDITIONS

CHICKEN	6
POACHED SHRIMP	7
BACON	2
GLUTEN FREE BUN	3
SIDE CAESAR SALAD	6

CHEF SPECIALTIES

CHICKEN BACON RANCH	17
grilled herb chicken, bacon, arugula, tillamook swiss cheese, tomato, and ranch on a toasted brioche bun	
TILLAMOOK BURGER	16
6oz Angus patty, tillamook cheddar cheese, grilled onion, tomato, arugula, and garlic aioli on a toasted brioche bun	
VEGGIE BURGER	14
grilled veggie patty, arugula, tomato, onion, and garlic aioli on a toasted brioche bun	
MUSHROOM SWISS BURGER	16
6oz Angus patty, tillamook swiss cheese, grilled onions, mushrooms, and garlic aioli on a toasted brioche bun	
SHORT RIB RAGU	29
slow braised beef short ribs, simple vegetables, fresh herbs, and tomatoes all tossed in pappardelle noodles	
CREAMY LEMON BASIL PASTA	19
fettuccine noodles tossed in a lemon basil cream sauce	
CHICKEN MARSALA PASTA	25
grilled herb chicken, sautéed onion and mushrooms served on fettuccine in a rich marsala cream sauce	
BACON MAC & CHEESE	13
a larger portion of the favorite kids mac and cheese topped with bacon	
ADD A SIDE OF FRIES OR SIDE SALAD TO ANY CHEF SPECIALTY	4



Roots

286 S Main St,
Independence
@rootsindependence

The Roots menu

includes:

- Toasts
- Salad Bowls
- Smoothies
- Acai Bowls
- Sandwiches
- Slow Pressed Juices

"We use organic ingredients whenever possible. House-made sourdough. No artificial dyes. No seed oils."



TERRITORY

Explore. Savor. Sip.

201 OSPREY LN.
INDEPENDENCE, OH 97351

ALL PARTIES OF 6 OR MORE WILL
BE SUBJECT TO A 20% GRATUITY

*CONSUMING RAW OR UNDERCOOKED MEATS, POULTRY, SEAFOOD, SHELLFISH, OR EGGS MAY INCREASE YOUR RISK OF FOODBORNE ILLNESS, ESPECIALLY IF YOU HAVE CERTAIN MEDICAL CONDITIONS.



April 14 is National Gardening Day. National Gardening Day on April 14th encourages gardeners and would-be gardeners to pick up a shovel, plant some seeds, and kick off a beautiful year of homegrown bounty.



At The Mid-Willamette Valley Council of Governments' award banquet, The Wall That Heals in Independence was honored with the 2025 Regional Cooperative Project Award.

Bringing this traveling replica of the Vietnam Veterans Memorial to Oregon was a true regional effort. Over 18 months, 17 local governments, state agencies, nonprofits, and more than 200 volunteers worked together to plan and execute the event. Highlights included a motorcade through four cities led by veterans on motorcycles and Corvette club members, a 24-hour memorial site operation in Independence, a Blackhawk flyover, a 21-gun salute, and a daily bugler performing Taps.

More than 8,600 visitors came to honor veterans, participate in guided tours, and experience the history of the Wall first hand. Hosting The Wall That Heals demonstrated the impact of what's possible when cities, counties, nonprofits, and communities move together as one.



The Independence Downtown Association quarterly meeting is April 2, 6 PM at Territory Restaurant, Independence Hotel. It's open to EVERYONE. Come find out what's happening! info@downtownindependence.com

The following information is provided by INDEPENDENCE DOWNTOWN ASSOCIATION

FARMERS MARKETS

2 markets in Independence: waltonsgarden@yahoo.com, independenceriverviewmarket@gmail.com

TOUCH A TRUCK

For information contact ci.independence.or.us

MID-MAY: FLOWER BASKETS

Walk of Hearts income purchases beautiful downtown baskets. An IDA activity

JUNE: THE LAST DAY OF SCHOOL CELEBRATION

Happening on the last Friday of school. From 3-5 PM kids celebrate with free handouts. An IDA activity

GRADUATION

At Central High School & Western Oregon University

INDEPENDENCE DAYS:

July 4th fun at Riverview Park/ amphitheater

THE HOP & HERITAGE FESTIVAL

A Fresh Hop Festival, wine tasting in the businesses, and music on the sidewalks. An IDA activity

THE GHOST WALK

1st Saturday of October, begin with Apparition Avenue, then the Ghost Walk
Sponsored by Heritage Museum,

Independence and Parking Meters

Did you know that Independence used to have parking meters on Main Street?

The meters were installed by 1950. Some reports say they remained until "the 60s". But by 1950 arguments about those meters were already underway.

From a 7-15-1950 news article:

Independence Meters In

A business-sponsored drive to bring a vote on parking meters failed of its purpose yesterday when voters approved keeping the gadgets by a vote of 237 to 143.

From the June 23, 1950 news:

Independence Voters to Decide Parking Issue

The fate of Independence's parking meters will be decided in an election set tentatively by the city council for July 15.

The matter was brought to a vote after some business men and farmers complained that shoppers were trading in neighboring cities to avoid the parking charge.

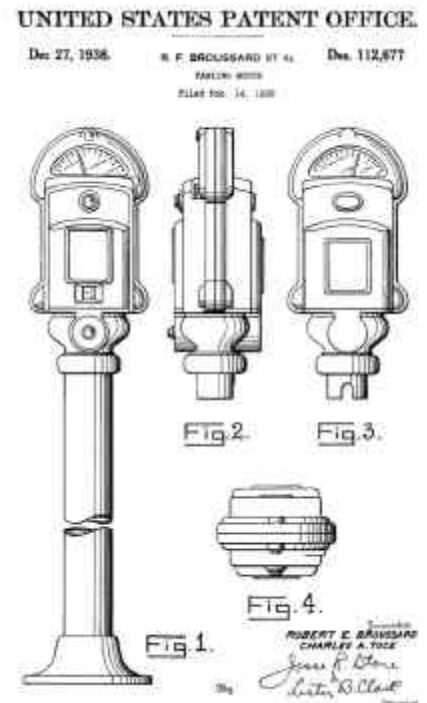

orheritage@ci.independence.or.us

OCTOBER 31: TRICK OR TREAT DOWNTOWN

Trick-or-Treat at the businesses. Independence, 3-5 PM, Monmouth, 4-6 PM.

An IDA activity in collaboration with MBA

SHOP SMALL SATURDAY

Right after Thanksgiving

WREATHS AND DÉCOR DOWNTOWN

Lighted wreaths for all the light poles downtown. An IDA/City of Independence event



LIMITED OFFER

EASTER IS APRIL 5TH

\$10 per egg or 3 for \$25



Monday	1:00pm - 8:30pm
Tuesday	Closed
Wednesday	10:00am - 4:30pm
Thursday	10:00am - 8:30pm
Friday	9:00am - 8:30pm
Saturday	9:00am - 6:00pm
Sunday	Closed

See our class schedule on our website or by clicking "Book Me" on Facebook

MOTHER'S DAY IS MAY 10TH

\$20 per mini painting



Heads up!

We will be closed

April 15 - 20th

for our trip to learn more cool skills @ America's Largest Glass Craft & Bead Expo!

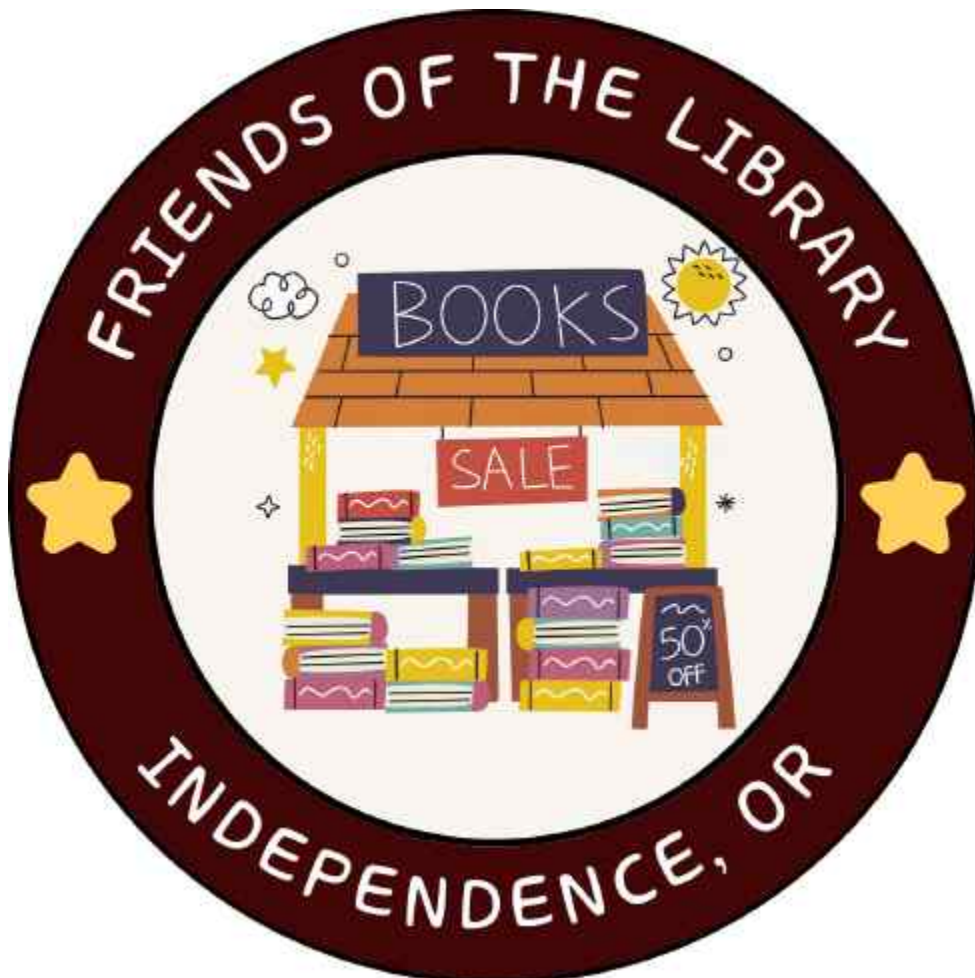

BOOK SALE!

Saturday,

April 4

10 AM to 3 PM

Old Library

311 Monmouth St

Independence

Supporting the

Friends of the

Independence

Library



**A LITTLE POLICE HISTORY...
Police Warrants Written in Past Aprils**

In 1958 a parking citation cost \$1, having your dog put into the pound cost the owner \$2 in “bail”, and a charge for driving under the influence was a hefty \$225

In 1961 parking violations were \$2, drunk on the street or disorderly conduct earned a \$25 citation, and a “penal violation” was \$100

In 1962 parking citations were still \$2, releasing your dog from the pound cost \$2.50, driving without a license was \$20, a speeding ticket was \$50, and various tickets for drunk in auto, drunk on street, or disorderly conduct cost from \$10-\$25

In 1963 parking citations or disobeying traffic signals cost from \$1-3, springing a dog from the pound was back to \$2, a “municipal warrant” was \$25, and drunk on street, or disorderly conduct was fined \$15-\$30



“A CLEANER, HEALTHIER BODY FIXES ITSELF”

This is the defining philosophy of Avini Health. We are a leading health technology company, providing unique, one-of-a-kind solutions that remove heavy metals, VOC’s and other toxins from the body, not just the digestive tract like every other “cleanse and detox” program, but right down to the bone. All organic, non-toxic and completely safe for children, pregnant women, the elderly and even pets.

Environmental toxins found in our air, water and soil are at an all-time high in terms of volume and variety. Our bodies are exposed to at least 700 chemicals on a daily basis and the health of America is at stake. Most of the chronic conditions we are experiencing as a nation are a result of these toxins. Avini Health offers preventative and healing methods of reducing and eliminating disease, discomfort and despair.

This International Medical Technology company provides hygienic cleaning on the INSIDE to remove, replenish and restore, transforming your body and extending your life with vibrant longevity. Whether you’re looking to lose weight, boost your energy levels, address a specific health concern or just improve your overall health, Avini Health has the natural solutions you need to achieve your goals.

For more Information, contact:
Kari Roper, RN, BSN
Certified Health Coach
#503-510-8719
healthcoachkarir@gmail.com





ASH CREEK ARTS CENTER

INVESTIGATE • EDUCATE • CREATE



Tuesday Night Adult Class:
Still Life Painting with Toben Roark
April 7, 6:30-8:30 PM
All materials provided by ACAC



PreK Art Adventures with Toben Roark
April 8, April 15, & April 22, 10 AM
Recommended for elementary aged artists. All supplies provided by ACAC.



“Drawing” Youth Class with Maia Jones
April 11, 10 AM-12 PM
All supplies provided by ACAC.



Thursday Adult Art Class (16+),
April 16, 6:30-8:30 PM
All materials provided by ACAC



Adaptive Arts Guild, ages 9-15, with Ash Earls
April 15, 6-7:30 PM
All materials provided by ACAC



Adult (16+) Drawing Class with Jessica Rehfield
April 22, 6:30-8:30 PM
All materials provided by ACAC



Saturday Adult Art Workshop (16+) with Sonia Allen
April 25, 10 AM – 3 PM
All materials provided by ACAC

ASH CREEK ARTS CENTER (ACAC), is a 501(c)(3) organization, funded since 2010 by donations and grants. At 311 Monmouth St, Independence. **Your donations are always**





HERITAGE MUSEUM PRESENTS SPEAKER SERIES

APRIL FEATURED SPEAKER

THURSDAY, APRIL 9TH AT 6:00 PM
@ THE VALKYRIE WINE TAVERN

YES! YOU CAN GROW OLIVE TREES IN OREGON



Join us for an evening with Bryan Brown & Barbara Porter to learn how olives grow, how the new industry is taking root in our state and what it takes to grow them successfully here in the Willamette Valley. Whether you're thinking about planting your own tree or just curious, this is a great place to start.

SUGGESTED DONATION AT THE DOOR

Drinks are not included in your donation
All proceeds support the Heritage Museum Society

301 S MAIN ST, INDEPENDENCE
No minors or outside drinks permitted



eClub of the Willamette Valley

21st Annual Community Baby Shower

Saturday, April 18, 2026
10:00 AM – 12:00 PM
Willamette Health Council office
1701 Liberty St SE in Salem

Drop off new or handmade items for babies and children in low-income families in Marion and Polk Counties.

Suggested Items:

Disposable diapers	Board books	Wipes
Blankets and quilts	Pacifiers	Socks
T-shirts/onesies	Sleepers	Bottles
Bottle Brushes	Shampoo	Baby toys
Knitted booties, hats, blankets, sweaters, etc.		

Monetary donations also accepted the day of the shower, or mail checks payable to South Salem Rotary Foundation at the following address: % Marcy Crenshaw, 1625 Snow Peak Ct, Stayton, OR 97383

Credit, Debit and PayPal donations are also accepted at southsaalemrotary.org under the Donate tab and indicate use of donation for the Annual Baby Shower.

For more information or to arrange pick-up, call Marcy Crenshaw at 503-507-4770
South Salem Rotary Foundation is a 501(c)(3) organization.

Or choose an option off the Amazon Wishlist:



Quarterly Town Hall

Thursday, April 30 5:30 pm - 7:00 pm

151 Main Street | Council Chambers



EARTH DAY: APRIL 22

The stage play "Hair" opened on April 29, 1968.

Did you know its full name was *Hair: The American Tribal Love-Rock Musical*?

At least 5 top-40 songs came into our musical vernacular due to *Hair*.

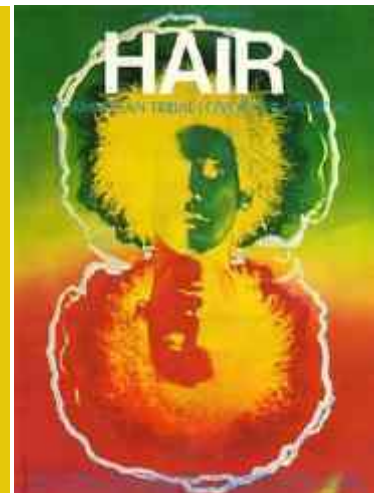



WESTERN OREGON UNIVERSITY HOME GAMES & TOURNAMENTS

- April 3:** Baseball vs Northwest Nazarene University, 1 PM
- April 3:** Softball vs Montana State University Billings, 1 PM
- April 3:** Softball vs Montana State University Billings, 3 PM
- April 3:** Baseball vs Northwest Nazarene University, 4 PM
- April 4:** Baseball vs Northwest Nazarene University, 12 PM
- April 4:** Softball vs Montana State University Billings, 12 PM
- April 8:** Baseball vs George Fox University, 3 PM
- April 10:** Track & Field, John Knight Twilight
- April 10:** Baseball vs Central Washington University, Ellensburg, 12 PM
- April 11:** Track & Field, John Knight Twilight
- April 17:** Baseball vs Montana State University, Billings, 1 PM
- April 17:** Baseball vs Montana State University, Billings, 4 PM
- April 18:** Softball vs Saint Martin's University, 1 PM
- April 18:** Baseball vs Montana State University, Billings, 1 PM
- April 18:** Softball vs Saint Martin's University, 3 PM
- April 18:** Baseball vs Montana State University, Billings, 4 PM
- April 19:** Softball vs Saint Martin's University, 12 PM
- April 19:** Softball vs Saint Martin's University, 2 PM

CENTRAL HIGH SCHOOL HOME GAMES & TOURNAMENTS

- April 2:** Baseball vs La Salle Prep, 5 PM
- April 2:** Boys Tennis, Central Dual BTN Meet, TBD
- April 7:** Girls Tennis, South Albany, Kings Valley Charter Dual GTN Meet, 4 PM
- April 7:** Tennis, South Albany Dual BTN Meet, 4 PM
- April 7:** Baseball vs McNary, 5 PM
- April 9:** Girls Tennis, McKay Dual BTN Meet, 4 PM
- April 13:** Baseball vs Woodburn, 5 PM
- April 13:** Softball vs Lebanon, 5 PM
- April 14:** Girls Tennis, Woodburn Dual BTN Meet, 4 PM
- April 15:** Softball vs Tillamook, 5 PM
- April 17:** Baseball vs South Albany, 5 PM
- April 17:** Baseball vs Lebanon, 5 PM
- April 18:** Boys & Girls Track & Field John Oliver Invitational, 10:30 AM
- April 20:** Baseball vs Silverton, 5 PM
- April 21:** Girls Tennis, Silverton Dual BTN Meet, 4 PM
- April 23:** Boys Tennis, Central Dual BTN Meet, 4 PM
- April 27:** Baseball vs Crescent Valley/Kings Valley Charter, 5 PM
- April 30:** Girls Tennis, Central Dual BTN Meet, 4 PM

Ask Me Anything!

MAYOR OFFICE HOURS

Every Wednesday morning, 8:30 - 10:30 AM |
Ash Creek Conference Room, Independence Civic Center



Mayor Kate Schwarzler

Friends of the Monmouth Senior Center Pancake Breakfast

First Saturday of every month, 8:30 AM,
Monmouth Senior Center, 180 S Warren
St, Monmouth. Join us the first Saturday
of every month: for \$10 all-you-can-eat
pancakes, eggs, sausage, biscuits &
gravy, juice, and coffee.

We'll save a seat for you!

**NEXT PANCAKE BREAKFAST IS
MARCH 7TH**



*Thank you, MINET, for
free wi-fi on the
trolley!*



TRI-TIP *Thursday*

**WHISKEY SMOKED
TRI-TIP
OR
MARRY ME CHICKEN
(SUN DRIED TOMATOES W/CREAM
SAUCE)
SMOKED MAC &
CHEESE
BABY REDS
GARDEN SALAD
ROLLS WITH BUTTER
ONLY \$18 PER
PERSON!**

JOIN US

**THURSDAY
April 9 & 23
5:30-7:30 PM**

Location:

**Brew Coffee & Tap House
211 S. Main Street, Independence**



April 18 is National Piñata Day

The piñata's origin is apparently shrouded in some mystery. Origin stories come from China, where piñatas were observed by Marco Polo who brought the idea back to Italy. Piñatas migrated to Spain. From there, Spanish missionaries shared concept with the Aztecs. The Aztecs already had a practice of breaking pots in their religious celebrations. Piñatas were once used in a ritual to atone for sins. Later candy and treat fillings were common.

The name, according to some scholars, comes from "pignatta", an Italian word for a fragile terracotta pot.

Now, the piñata, the stuff of legend it seems, is enjoyed cross-culturally.



GOLDEN HOP SALOON

133 C ST. * INDEPENDENCE, OR 97351

WEEKLY SPECIALS:

MONDAY:

**BOGO 50%
BURGERS**

TUESDAY:

**Happy Hour
ALL DAY**

WEDNESDAY:

**WOU
WEDNESDAYS**

THURSDAY:



FRIDAY:



SAT & SUN:





Drawing with Carol Chapel is every third Sunday of the month from 1:00pm-2:00pm at River Gallery.

Supplies and materials will be provided. Bring your smile and join in on the fun!

River Gallery
 184 S. Main Street
 Independence,
 Oregon 97351
 503/838-6171
 rivergalleyart.com



1ST SUNDAY OF EVERY MONTH EXCEPT AUGUST. POLK COUNTY FAIRGROUNDS ON HWY 99. OVER 100 VENDORS, 3 BUILDINGS, VINTAGE GOODS, COLLECTIBLES, ANTIQUES, WEIRD WONDERFUL UNIQUE FINDS.

Early Bird Shoppers \$5, 6-9am. General admission \$1, 9am-3pm. Free Parking. Follow us on Facebook.

April 21 is BIG WORD DAY. Here's what we found out about the current biggest words: At 45 letters, this is the longest word in the English dictionary (names a lung disease): **pneumonoultramicroscopicsilicovolcanoconiosis**. The name of the "Fear of Long Words" itself has 36 letters: **Hippopotomonstrosesquippedaliophobia**. A very long word (but only 28 letters) drifted through many a students' vocabulary: **Antidisestablishmentarianism**, describing some Church of England politics.

AGE CAFE
 MONTHLY SOCIAL GATHERINGS
 AT 10:00AM

Aging: Everybody's Doing It!

Age Café meets at 10 AM on the Second Thursday of each month

MONMOUTH SENIOR COMMUNITY CENTER
 180 WARREN ST. S, MONMOUTH, OR
 503-838-5678



A PLACE FOR ALL SEASONS,
 ROOTED IN COMMUNITY.



The third Saturday of each month in 2025. All ages and crafters of all kinds welcome! Bring your own hobbies and food/snacks for the day.

10:00am to 4:00pm

**Community
 Craft Days**

A NIGHT IN NEW YORK



DADDY DAUGHTER DANCE

Saturday April 11th, 4:00-7:00 P.M.
The Withnell Family YMCA
685 Court St. NE Salem, OR 97301

Tickets are now on sale! TheYonline.org



UNA NOCHE EN NUEVA YORK



BAILE DE PAPÁ E HIJA

Sábado 11 de abril, 4:00-7:00 P.M.
The Withnell Family YMCA
685 Court St. NE Salem, OR 97301

¡Los boletos ya están a la venta! TheYonline.org



Western Oregon UNIVERSITY

Creative Arts

Concerts

- Wednesday, April 1 through Friday, April 3, All Day, Great Western Music Championships Concerts, Rice Auditorium.



Art Exhibits

- Now through May 8, Still, Art Exhibit: Still, They Speak, Paintings by Don Bailey & Joy Kloman, All Day, Cannon Gallery, Campbell Hall



INSURANCE GROUP



KAREN FRASCONE

Owner
karen@kinsuregroup.com

Let's Talk Health Insurance!

NO COST HELP

Medicare,
Individual, Life,
Marketplace,
Small Group
Representing all major carriers

503.838.1158
kinsuregroup.com

1327 Monmouth St.
Independence, OR

BUSINESS SPOTLIGHT



With over 20+ years of experience, Azucena's Cleaning provides a wide variety of residential and commercial cleaning options in Monmouth and surrounding areas. Business owner, Azucena Alvarez, and her family, have worked diligently to build their business from the ground up to the thriving business it is today. From residential recurring weekly, bi-weekly, monthly and one-time cleanings to move in/move out, new construction and commercial/office cleaning, Azucena's Cleaning works closely with their clients to address all their cleaning needs. They also provide window washing, power washing, junk removal and gift certificates.

Business owner Azucena's pledge is to conduct business honestly, observe a professional code of ethics, while maintaining the highest standard of workmanship and service. Staff are trained in approved cleaning methods to clean your home or business with maximum safety and skill. They are committed to providing your home with top quality cleaning; while also doing their part to protect the world we live in with the use of natural products.

Interested in booking a spring cleaning or free quote? Contact them by phone (503.779.5906) or email (azucenascleaning@gmail.com).



 www.azucenascleaning.com

  @azucenascleaning



More Books & Libraries celebrated...

April 10 is National Bookmobile Day.

Look what we have!

Independence Library Director Patrick Bodily demonstrates the new bicycle bookmobile.







One time cleaning or regularly scheduled visits bi-weekly, weekly, or monthly.

- Free Estimates
- Professional Carpet Cleaning
- Window / Screen Cleaning - In & Out
- Residential / Commercial
- Office/Home Maintenance
- Move In / Move Out Cleaning
- Spring Cleaning • Pre-Letting Cleaning
- Blinds • Power Washing • Air Duct Cleaning



SATISFACTION GUARANTEED



BILINGUAL



\$100 OFF

CLEANING!

Receive \$100 Off your third completed service!
Offer valid 12/31/2025

503.779.5906

azucenascleaning@gmail.com

HONDED & BOUND

www.azucenascleaning.com



CURRENT RIVER GALLERY EXHIBIT

On April 9th, 2026, River Gallery will be featuring an exhibit of Anne Jankowski's art work. Anne has been at River Gallery for several years and she is a local artist. Her paintings create a feeling of solitude and focuses on the beauty of nature. This will be an exhibit you definitely want to see!



Left: Work by Anne Jankowski

**River Gallery
184 S. Main Street, Independence**

**Open: Thursdays - Sundays
from 11:00am to 4:00pm**

**Rivergalleryart.com
rivergallery97351@gmail.com
Phone: 503/838-6171**

CALL TO ARTISTS: "Wild Women Show". Theme: "Transitions"

Art drop off dates are Thursday, 5/21/2026 through Sunday, 5/24/2026 from 11:00am - 4:00pm.

Art exhibit runs through Thursday, 5/28/2026 through Sunday, 6/28/2026 from 11:00am - 4:00pm.

Art pick up dates are Saturday, 6/27/2026 through Sunday, 6/28/2026 from 11:00am - 4:00pm.

The reception is on Saturday, 6/13/2026 at River Gallery from 4:00pm - 8:00pm.

This is a non-juried exhibit.

The hanging fee is \$30 and limited to one art piece per artist. All artwork must be for sale.

So put it on your calendar! If you are an artist, this is the time to prepare for the "Wild Women Show"!

Check our website for updates and/or additional information.

Pictured to the right & below, prior Wild Women graphics





Sponsor an Event

Western hosts many events throughout the year that your business can sponsor! Some examples include:

Wolves Athletics

- Wolves Athletic Auction
- Wolves on the Green Golf Tournament
- Hoop & Howl

Campus Programs

- Smith Fine Arts Series
- Academic Excellence Showcase
- Art & Wine Fundraiser
- Cesar E. Chavez Leadership Conference
- Block Party
- Family Weekend
- Homecoming

Student Clubs and Organizations

- Club Sports
- Veterans Banquet
- Diversity Scholars Dinner
- Hawaii Club Lu'au

In-kind sponsorship opportunities are also available!

WOU Fast Facts

- Oldest public university in Oregon
- #1 producer of licensed teachers in the state of Oregon
- 84% in-state students
- 50% first-generation college students
- 40% students of color
- Oregon's first public, four-year Hispanic Serving Institution
- Athletics: NCAA Division II
- Great Northwest Athletic Conference
- Mascot: Wolves
- 14 NCAA sports and cheer



For more information about all the events your business can be a part of at Western, contact G. David Beasley at beasleyg@wou.edu.

Join the Pack: A BUSINESS OWNER'S GUIDE TO WOU



Western Oregon University



wou.edu

Hire a Wolf

The Center for Professional Pathways

When it comes to hiring top talent, we know you have a lot of options. Whether you're new to recruiting our Wolf candidates or gearing up to hire more, our team is here to make recruiting as easy as possible.

Looking to hire a student employee or intern?

Advertise job openings on Handshake!

Want to come to campus and meet students?

Sign up for one of our regular ProConnect, Career Connect, ProChat, and/or job fairs on Handshake!



Scan here to learn more about how to hire a Wolf!



wou.edu/professional-pathways/employers

WOU Wednesday

WOU Wednesday offers the chance to show your Wolf pride by offering discounts/specials for customers wearing WOU gear or showing a WOU ID. It's a great chance to market to over 4,000 students, and our faculty and staff!

Benefits of WOU Wednesday

Featured on WOU Wednesday website

- Highlighted regularly on social media
- Increased visibility for your business among WOU students, faculty, and staff!
- Free t-shirts for employees

Scan below to learn more and sign up for WOU Wednesday.



Have questions about signing up? Already signed up but need more t-shirts for your employees?

Contact G. David Beasley at beasleyg@wou.edu

Advertise with Western

Increase your company visibility and reach a diverse audience by advertising with Western. Affordable interior, exterior, and digital advertising opportunities available.



We offer advertising in the following spaces and/or programs:

Wolves Athletics

- McArthur Field (Football)
- Wolves Athletic Center (Basketball, Volleyball)
- Baseball Field
- Softball Field

Campus programs

Smith Fine Arts Series

Student Media

Western Howl (student newspaper)

For more information about how to advertise with Western, contact G. David Beasley at beasleyg@wou.edu

**April 2026
Adult Programs**

A holistic approach to wildlife management.

Backyard Wildlife

**April 18
11:00 am**

Learn what constitutes problem wildlife, approaches for dealing with the most common challenges, and how to make space for wildlife in our gardens and outdoor living areas.

Presented by experts in ecology and animal behavior, **Chris Baumgartner** and **Patrick Aldrich**.



308 Ecols St. S.
603-838-1932

GOOGLE DOCS

FREE COMPUTER CLASS

**April 14
1:00-2:30**



Career Center

Explore the potential of the free word processing software, Google Docs. Practice using the drop-down menus, then learn how to download, upload, and share Docs. Students must have Google account to participate.

The mission of Countywide Initiatives of the Columbia-Warrenton Economic Development Authority is to provide educational opportunities to improve skills, knowledge and employment of individuals in the community. To support this mission, CWEDA's Career Center program provides free workshops to community partners in Clatsop and Clatskanie Municipalities.



Gideon Freudmann *Special Sunday Concert*

CelloBop



**APRIL 26
1:00-2:00**

Using the electric cello for improvisational music, Gideon Freudmann sits on conventions and traditions of classical, blues, jazz, electronic, funk and folk.



308 Ecols St. S.
603-838-1932



This story was shared with us by the City of Monmouth.

It originates from the Main Street Organization, with which both Monmouth and Independence are engaged.

In Oregon, a fare-free trolley is strengthening the connection between two historic downtowns. The Monmouth-Independence Trolley links residents, students, businesses, and visitors. The trolley is increasing foot traffic, supporting small business, and creating memorable community experience through themed rides and special events.



Creating community connections, one trolley ride at a time

APRIL 2026 Monmouth Public Library Youth Events

**FAMILY STORYTIME
TUESDAYS AT 10:30 AM**

Join Librarian Hilary for our spring series full of stories, songs, and fun, followed by a craft! Ideal for ages 3 - 5.



**BOUNCES & RHYMES
THURSDAYS AT 10:30 AM**

Join Librarian Hilary for our spring series full of bounces, rhymes, and songs, followed by a stay-and-play. Ideal for babies through age 2. **No program April 23.**

**TAIKO DRUM WORKSHOP
REGISTRATION REQUIRED
AGES 5 - 8: APRIL 10 AT 1:00 PM
AGES 9 - 18: APRIL 10 AT 1:45 PM**

Come learn about Japanese Taiko drumming with Monmouth Taiko! Listen to the group play, then learn some techniques and get hands-on practice. Contact the library to register.



**CRAFT WITH A COP
APRIL 29 AT 1:30 PM**

Join us at the library to do crafts with Monmouth's very own police officers. For all ages.



**FAM JAM
POLK COUNTY FAIRGROUNDS
APRIL 25 FROM 10:00 AM - 2:00 PM**

The biggest little party. Join for a day of resource connection, kindergarten registration information, and family fun! Sponsored by Mid-Valley Parenting and Polk County FCO.



**(503) 838-1932
168 Ecols St S**

**Tuesday-Friday
10:00 am-6:00 pm
Saturday
10:00 am-4:00 pm**

MUSIC JAM NIGHT
Second Wednesday of each month at 6:30pm.

UKULELE JAM NIGHT
Third Wednesday of each month at 6:00pm.

Monmouth Senior Community Center
180 Warren Street South
Monmouth, OR 97361
503-838-4874

MONMOUTH SENIOR COMMUNITY CENTER
A PLACE FOR ALL GENERATIONS
WORKING IN A COMMUNITY

Pentacle Theatre

Something Rotten!
The Hit Broadway Musical Comedy

Book by:
Harey Kirkpatrick & John O'Farrell

Music & Lyrics by:
Wayne Kirkpatrick & Harey Kirkpatrick

Directed by:
Robert Salberg

Opening: **March 20**
Closing: **April 11**

Theater Location:
324 1/2nd Ave. SE
Salem, OR 97304
West of Salem, off Hwy. 22

Ticket Office:
(503) 488-4100
327 Liberty St. SE
Salem, OR 97302

PentacleTheatre.org

Books and Libraries Celebrated in April

April 2 is International Children's Book Day.

The first Children's Book ever published, way back in 1744, was called "A Little Pretty Pocket-Book.

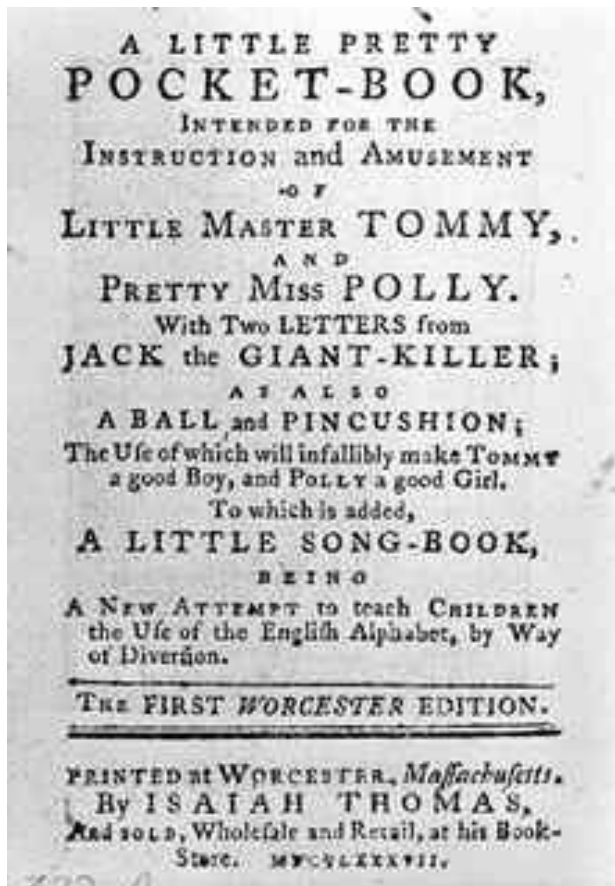

April at the Pentacle Theatre:

- Wednesday, April 1, 2026 | 7:30 PM**
- Thursday, April 2, 2026 | 7:30 PM**
- Friday, April 3, 2026 | 7:30 PM**
- Saturday, April 4, 2026 | 2:00 PM**
- Saturday, April 4, 2026 | 7:30 PM**
- Sunday, April 5, 2026 | 2:00 PM**
- Wednesday, April 8, 2026 | 7:30 PM**
- Thursday, April 9, 2026 | 7:30 PM**
- Friday, April 10, 2026 | 7:30 PM**
- Saturday, April 11, 2026 | 7:30 PM**

SUPPORT WHAT YOU LOVE ABOUT INDEPENDENCE

You now have the option to financially support the Independence Public Library, Museum, and Parks either with a one-time donation or by becoming a monthly supporter.

INDEPENDENCE
Regional Library District, Inc.





April 2026

Independence Public Library





SUNDAY	MONDAY	TUESDAY	WEDNESDAY	THURSDAY	FRIDAY	SATURDAY
1			1 Storytime 10:30 am ----- Kid's Coding 4 pm	2	3	Friends Book Sale 10-3 pm
5 Happy Easter	6	7	8 Storytime 10:30 am ----- Kid's Coding 4 pm	9 Teen & Adult Lacy Bowl Art 4 pm	10	11
12	13	14 Minion Madness Party 4 pm	15 Storytime 10:30 am ----- Kid's Coding 4 pm	16	17	18
19 National Library Week →	20	21 Mystery Book Club 4 pm	22 Storytime 10:30 am ----- Kid's Coding 4 pm	23 Family Coloring Club 4 pm	24	25
26	27	28 Chair Yoga with Winnie 11 am	29 Storytime 10:30 am ----- Kid's Coding 4 pm	30	Independence Public Library 175 Monmouth Street Independence, OH 97351 503-838-1811 www.ci.independence.or.us/library Open Monday - Thursday 11-6 pm	

JOIN US AT
HAZELS'S ON MAIN
FOR A
Watercolor Paint 'n Sip
SUNDAY, APRIL 26TH
FROM 2:00 - 4:00 PM

DIY PET PORTRAIT
\$45 PER PERSON
SCAN FOR TICKETS!

Rough Cut Vintage
136 Monmouth St, Independence
503 508-7729. NOW OPEN!



PRESS RELEASE

RELEASE DATE: 3/18/2026

Monmouth–Independence Community Foundation Celebrates a Year of Growth and Community Impact in 2025

Monmouth, Oregon – The Monmouth–Independence Community Foundation (MICF) is proud to reflect on an extraordinary year of growth, generosity, and impact across the Monmouth and Independence communities. As the organization celebrated its 25th anniversary in 2025, the foundation marked a milestone year of strengthening educational opportunities, expanding community partnerships, and increasing support for local programs that enrich residents' lives.

In 2025, MICF increased scholarship awards for local graduating seniors, helping more students pursue their educational and career goals. The foundation also expanded its community grant program, providing funding for innovative classroom projects, resources for teachers and students, and programs that strengthen the region's social and cultural fabric.

One of the foundation's key accomplishments was the growth in partnerships with local businesses, organizations, and civic leaders, creating more opportunities for community engagement and ensuring resources are directed where they are most needed.

Since its founding in 2000, MICF has helped support over \$1 million in scholarships, classroom enrichment projects, and community programs. Today, the foundation holds over \$4 million in funds, including contributions from 19 community partners.

None of this work would be possible without the generosity of local donors, volunteers, partners, and community members who believe in the power of investing locally. Donations can be made online at www.mifoundation.net.

"Every scholarship awarded and every grant distributed represents the collective generosity of our community," said MICF leadership. "We are grateful for the individuals and organizations who continue to support our mission and help us create opportunities for students and families across Monmouth and Independence."

As MICF looks toward the future, the foundation remains committed to expanding its impact and continuing to invest in the success of local students and community programs.

www.mifoundation.net

ELYSIUM

botanicals

WINES & VINEYARD

Wine Tasting: \$20 for 5 pours.

Tasting Room Hours of Operation:
 Thursdays 12pm - 8pm; Fridays & Saturdays
 12pm - 9pm; Sundays 12pm - 5pm.

Botanicals Plant Store, Wednesday to
 Sunday, 12-5 PM

8175 Buena Vista Rd
 Independence, Oregon 97351

Phone: (971)-465-7394

Email: Hospitality@Elysiumbotanicals.com

APRIL BIRTHDAYS of HISTORIC FIGURES

Buddha (Siddhartha Gautama), Prophet
 Butch Cassidy, Outlaw
 Charlemagne, King
 Clarence Darrow, Attorney
 Ferdinand Magellan, Explorer
 Guglielmo Marconi, Inventor
 Hans Christian Anderson, Author
 Henry Clay, Statesman
 James Buchanan, President
 James Monroe, President
 John James Audobon, Naturalist
 Joseph Pulitzer, Newspaper Publisher
 Leonardo DaVinci, Genius
 Ponce de Leon, Explorer
 Raphael, Artist
 Thomas Jefferson, President
 Ulysses S Grant, President
 Washington Irving, Author
 William Randolph Hearst, Newspaper Publisher
 William Shakespeare, Playwright

VETERAN'S CHAT FIRST TUESDAY EVERY MONTH 10-11 AM

MAKE NEW FRIENDS!

ENJOY COFFEE & DONUTS

OPEN TO PUBLIC
 JOIN US IN OUR DINING ROOM

503-831-8879 OR
 SAYHELLO@HERONPOINTESL.COM

Independent & Assisted Living for Seniors 55+

HERON POINTE
 SENIOR LIVING

heronpointesl.com
 504 Gwinn St. E.
 Monmouth, OR 97361

GUIDED BY GOODNESS, LOYALTY, FAITH, AND FUN

a Compass Senior Living community

American Legion Post 33 and the Heritage Museum present:

Veteran of the Month

Each month, the American Legion Post 33 and the Heritage Museum honor a local deceased veteran from Polk County.

On the second Saturday of the month at 1PM, participants meet at the museum, then walk to the Vietnam Veterans Memorial to raise the American and service branch flags. At month's end, the flag is presented to the veteran's family.

After the ceremony, attendees return to the museum for refreshments and to share stories.

To honor a veteran contact Billy Whisenant
 Phone: 805-574-9733 | Email: whitebloom@live.com



THE Play With Purpose PLACE

Looking for a youth sports program that goes beyond the game? At the Y, every pass, shot, and point builds skills that last long after the final whistle.

Youth Sports Programs at the Y Offer:

- Skill Development
- Teams For All
- Coaches Who Care
- A Safe & Fun Environment

Register Today For Spring Sports:

- Volleyball: 3rd-6th
- Soccer: 3 yr, 's-6th
- Flag Football: 1st-6th

The Monmouth Independence YMCA
503.858.4940 | TheYofore.org

SIGN UP TODAY 

BINGO AT THE ELKS LODGE



SATURDAYS AT 1 PM
\$20 ENTRY CASH PRIZES

INDEPENDENCE ELKS LODGE #1550
289 S. MAIN STREET INDEPENDENCE, OREGON



Join Launch Mid-Valley at Indy Commons at this monthly coffee club for business owners, entrepreneurs, and start-ups to connect and learn from one another. The next meeting is Thursday, April 23, 2026, at Indy Commons on Main Street, Independence

Monthly
Every 4th Thursday
at 9am!

Call for Art 2026

in the Monmouth City Hall Rotating Gallery
Theme "Anything Goes"
Landscape, Still Life, Abstract, Portrait, Photos, etc



Applications and guidelines can be found on line under the Arts & Culture Commission link under City Government @ <https://www.ci.monmouth.or.us> or by scanning the QR codes below

Application QR Code



Guidelines QR Code



AARPSM Tax-AideTM

Free Income Tax Preparation Services!
Both programs operate on Thursdays, Fridays and Saturdays from February 6 through April 11.
By appointment only.

AARP Tax-Aide Program

Offers free tax preparation services to low-to-moderate income taxpayers of all ages, but with a focus on those who are 60 years of age and older. You don't need to be an AARP member to take advantage of the Tax-Aide program.

Appointment requests will be accepted on or after January 15th. Visit our website or text/call 971-915-0316 to make your appointment.

VITA

Volunteer Income Tax Assistance



Western Oregon UNIVERSITY

MAKE YOUR APPOINTMENT:

Complete an Appointment Request through the QR Code



WOU VITA Program

Offers free tax preparation services to:

- People who generally make \$67,000 or less
- Persons with disabilities; and
- Limited English-speaking taxpayers

Many of our tax preparers are fluent in Spanish.

Appointment requests will be accepted on or after January 15th. Visit our website or text/call 503-751-4132 to make your appointment.



FAST-TRACK IN-PERSON PROJECT MANAGEMENT: LEARN & LEAD

In-Person training, must live in: Marion, Yamhill, Polk or Linn Counties



Pick your preferred dates!

February 19-20
March 12-13
April 16-17
8:30AM - 3:30PM

Location:

Chemeketa Center for Business and Industry



WHY YOU SHOULD JOIN

- No experience needed – beginner friendly
- Free food & study materials included
- Certificate of completion
- Just 2 days, high-impact training
- Great intro for PMP exam prep - quizzes
- Boost leadership & time management skills

WHO SHOULD ATTEND?

- Aspiring & current project managers
- Supervisors and team leads
- Professionals wanting to grow leadership & PM skills

Commit to Growth



FREE PMP® PREP TRAINING

This project management and leadership training provides professionals with essential skills to manage projects effectively, whether on the job or exploring professional certification. With a flexible format, it accommodates different schedules and learning preferences while offering 35 PMI PDUs for professional growth.

REGISTER NOW!

For Your Information...

Classes and Groups Descriptions

WEEKLY:

Yoga - M-F at 8:00am. Audio guided sessions for gentle, full body, meditative stretching. Mats available.

Beginning Stretch Exercise - M, W, F at 9:00am. Full body, low impact sitting and standing stretches and light free-weight work.

Chair Yoga - T, TH at 9:00am. Full body, low impact full body stretching.

Congregate Dining with Meals on Wheels - M, W at 11:00am. If you are new to the program, please fill out paperwork ahead of the day you come for lunch. Contact Cliff Simmons at 503-838-2084 to sign up for in-person lunch or delivery.

Tai Chi w/ Cheryl - M, F at 1:00pm. Slow, meditative movements connecting body and mind.

Community Dance Classes - T at 6:30pm. Ballroom style, \$10 per person.

Pinochle Cards - T, Th at 12:00pm.

Hand & Foot Cards - M at 10:00am. Variation of Canasta.

Cribbage - M at 10:00am. All ability levels welcome.

Beginning American Sign Language - M at 10:00am.

Technology Help w/ Ian - M from 1:00pm to 3:00pm. Get help using any mobile tech, no appointment necessary.

New Horizons Willamette Valley Orchestra - M at 6:30pm. Dust off your old instrument or try a new one. Call 503-838-4884 to join.

Wii Bowling - T at 9:00am.

Toenail Care with Dr. Mesdag - W by appointment only. Contact the office for your appointment, then see Dr. Mesdag at his office down the street.

Tai Chi w/ John - W at 10:00am. Promotes balance and calm.

Better Together Support Group - 1st & 3rd Wednesdays at 11:45am.

Ten Minute Writing - W at 1:00pm. Fun, no pressure prompted writing.

Connecting Loose Threads for Charity - W at 4:00pm.

Connecting Loose Threads - Th at 6:30pm. A community sewing group.

Creative Writer's Workshop - F at 10:00am. Writers share, critique, and support each other's individual projects.

Drawing for Fun - F at 10:00am. All abilities and interests welcome.

Jewelry Making - F at 11:00am. All abilities welcome.

All groups and classes are at the Monmouth Senior Community Center behind City Hall in Monmouth



A PLACE FOR ALL SEASONS,
ROOTED IN COMMUNITY

This information does not appear in the Community Calendar at the beginning of this publication

WISH LIST FROM
ELLA CURRAN

FOOD BANK

SOUP
HAMBURGER
HELPER
RICE A RONI
SPAGHETTI SAUCE
CHILI
CANNED FRUIT
CANNED CORN

CANNED CHICKEN
DICED TOMATOES
CEREAL
JELLY
TOILET PAPER
TOOTHBRUSHES
MONETARY
DONATIONS



Ella Curran Food Bank

How to help

- **Drop off donations:** Deliver food or monetary donations to 865 N Main St, Independence, during operating hours.
- **Volunteer:** Fill out a volunteer interest form on their website.
- **Donate online or by check:** Send monetary donations via their website or mail a check to the address on their website.

Watch us Grow:

The new Ella Curran Food Bank building is going up on Hoffman Road. So far franchise utilities & irrigation sleeves are installed, curbs and paving are in, and the bio-swale is under construction.

The Ella Curran Food Bank
is a 501(c)3 organization
870 N. Main St., PO Box 547
Independence
Mondays 4-6 PM
Tuesdays 9-11:30 AM, 4-6 PM
Thursdays 9-11:30 AM. 4-6 PM

THE POWER OF
ONE GREEN BAG

BUILDING COMMUNITY.
SHARING FOOD.

ONEGREENBAG.ORG
#ShareMore



THE ELLA CURRAN FOOD BANK
870 N. Main St., Independence, OR 97351
EllaCurranFoodBank@gmail.com, ellacurranfoodbank.org



Each month a few national and local news snippets will be shared, along with local advertising from 100 years ago this month.

Happening Locally

BUILDING UP ROADS

People Give Money or Labor Big Fill to be Put in South of Town

A car load of cement pipe and tile came in this week for improvement work on the 25 1/2 miles of county roads.

The cement pipe is 2-foot pipe and will be used to take the place of the Harnet bridge about 2 miles south of town on the river road.

The new road is the one west of Independence, running South. In the work on this road much volunteer labor has been given and considerable money by the people of this district, keeping expense at the minimum.

Eleven to sixteen men at different times have been doing some very effective work. There has been considerable grading and graveling done and the raking of big rocks from the road.

KOIN RADIO

KOIN Radio began broadcasting at 3 PM On April 12, 1926.

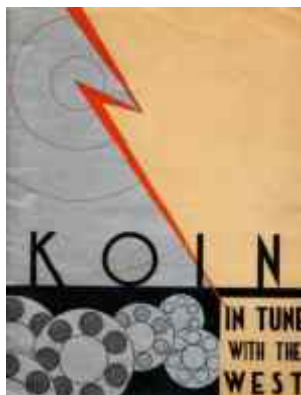

Happening in the Country/World

On April 15, 1926, Charles Lindbergh launched the first commercial airmail flight, traveling from Chicago, Illinois, to Peoria.

In April Hawaii's volcano, Mauna Loa, erupted

Sends fountains of Lava from Pit

The outbreak began at 3 AM. An uncanny glow over the countryside with a lane of fountains formed along the crest of the mountain. Before the eruption there were several earthquakes that rocked the island of Hawaii with tidal waves.

For 3 years Mauna Loa had been giving signs of coming to life.

The Volstead Act continues to aggravate

Debates, arguments and counter-arguments continue between the "wets" and "drys" about laws concerning prohibition.

THE ARTS

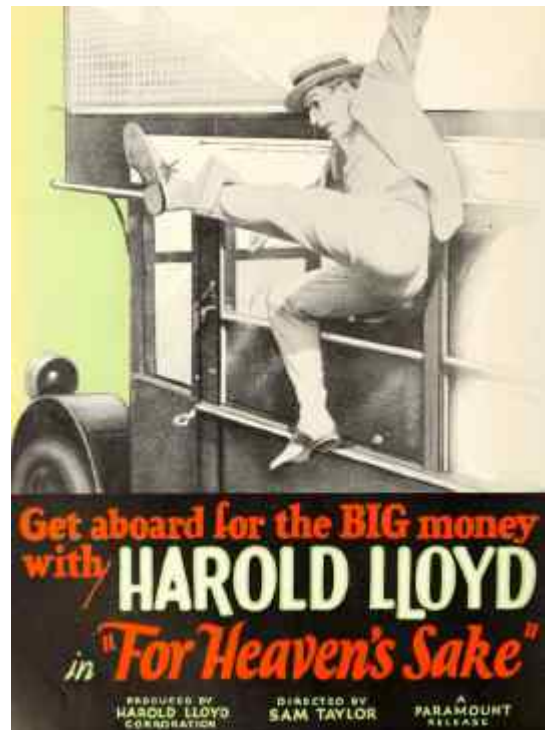

WOUTM WEDNESDAY



Receive discounts when you wear your WOU gear on Wednesday visiting these local businesses



More discounts are available in Dallas!

COMING EVENTS AND ATTRACTIONS

Looking Forward to What's Next

2C1C reserves an area in this online magazine to preview activities that are coming in the next month (and sometimes beyond). Your event can be previewed in this section. Recurring local ads are also featured here!



**34TH ANNUAL POLK COUNTY
MASTER GARDENER™ ASSOCIATION**

PLANT SALE

Mother's Day Weekend 2026



**Polk County
Fairgrounds
RICKREALL, OR**

**Friday, May 8:
9 AM - 4 PM
Sat., May 9:
9 AM - 2 PM**



**Home & Office Cleaning
You Can Trust!**

Get a Free estimate at:
503-580-6632
Licensed & Insured



**Out with the dust, in with
the fresh**

**\$100 OFF a Deep Clean
when you start recurring
service this spring**

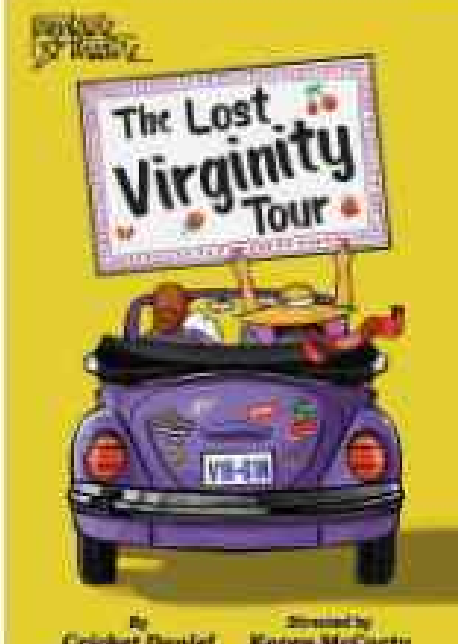

**The Lost
Virginitiy
Tour**

By Cricket Duxiel
Directed by Karen McCarty

Coming to Pentacle Theatre,
May 8 to May 30

MI Story Night at Valkyrie

THURSDAY, May 14
7:00 PM

VALKYRIE WINE TAVERN
INDEPENDENCE, OREGON

Join the Heritage Museum Society for a cozy evening of stories, as local writers and storytellers share original works drawn from their life and experiences right here at home.

PARTICIPATION IS BY INVITATION.

To learn more, contact HMS President Marilyn Morton
marilyn97351@gmail.com

or the Heritage Museum
orheritage@ci.independence.or.us

ARE YOU A WRITER??

Would you like to contribute a story for this event and read it or have it read aloud to an audience?

Please contact
marilyn97351@gmail.com, or
orheritage@ci.independence.
or.us to participate.

Story length is limited to 800 words.

All stories matching criteria will be published in a commemorative booklet, whether or not read at the event. Copies of the booklets will go to each contributor, each city, each library, and to Heritage Museum.



JUNE 16, 2026

3-5 PM

Top of the Park
in
Independence

TEDxMtHood

x = independently organized TED event

Theme: For the Common Good

Celebrating our 10th TEDxMtHood event!

A full day of ideas, performances, and community connection.

- ✓ 12 Speakers, 3 Performances, & Interactive Sessions
- ✓ Breakfast, Lunch & Reception Included
- ✓ 3 Main Stage Sessions
- ✓ Interactive Action Breaks

Saturday, May 16, 2026

Rice Auditorium at Western Oregon University
Monmouth, OR



Tickets and Speaker Roster at

tedxmthood.org



Smith Fine Arts Series  **Western Oregon UNIVERSITY**

SAT
6/6
2026

TAIMANE

Combining fierce rock, dance and ukelele—genres morph from classical to rock to flamenco

\$30 adults

\$10 Non-WOU students

WOU STUDENTS FREE!



Scan here to order tickets



Smith Fine Arts Series  **Western Oregon UNIVERSITY**

Western Oregon University

2025-2026 Events

More Upcoming Events & Notable Dates

- **April 3:** Save the Date! Alumni Awards Night.
- **April 7:** SAVE THE DATE! GIVING DAY.
- **May 8:** Cesar E Chavez Leadership Conference
- **May 30:** Wolves Athletic Auction

Save the Date!

Questions? Contact Admissions
Email: admissions@wou.edu
Phone: 503-838-8211

**MAIN STREET
ICE CREAM PARLOR**

109 MAIN ST E,
MONMOUTH
503 838-1485



Delicious
TACO TUESDAY



ROOKIESTAP.COM



**every thursday
at 7pm**

Free for all ages

WIN ROOKIES CASH

\$50 FOR 1ST
\$20 FOR 2ND
\$10 FOR 3RD

Coming in May:

Concerts

- Wednesday, May 27 & Thursday, May 28, 7:30 PM, “Language of Angles” Theatre Show , Rice Auditorium
- Thursday, May 28, 11 AM, Student Recital, Smith Recital Hall
- Friday, May 29, 7:30 PM, “Language of Angles” ASL Interpreted, Rice Auditorium
- Saturday, May 30, 2 PM, “Language of Angles”, Rice Auditorium
- Sunday, May 31, 7:30 PM, “Language of Angles”, Rice Auditorium

Art Exhibits

- Beginning May 16, 58th Annual Juried Student Art Exhibition, All Day, Cannon Gallery, Campbell Hall, & Flux Space , ITC Building

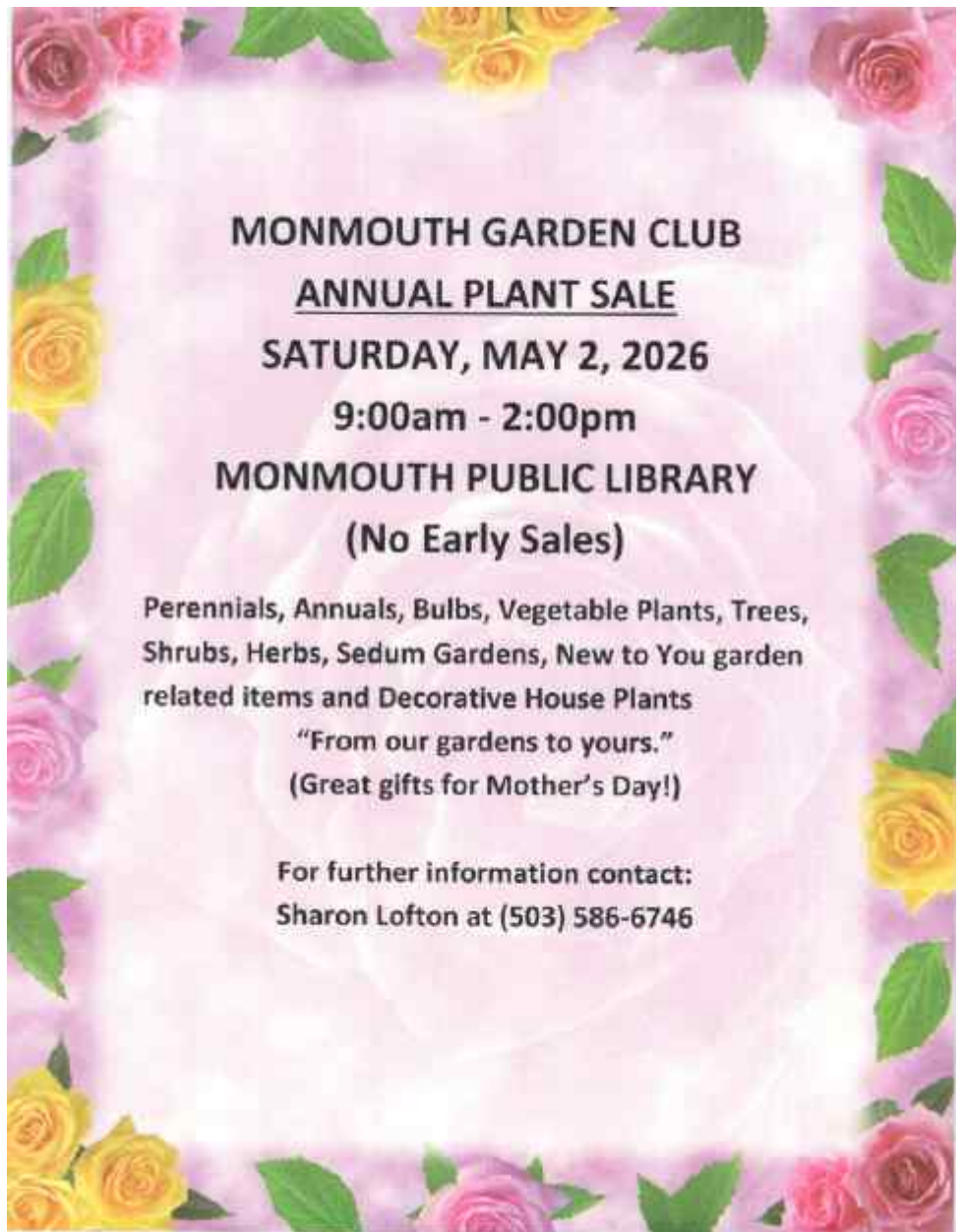

SENATOR PATTERSON & REPRESENTATIVE EVANS:

Senator Patterson’s and Representative Evans’ articles will be on hiatus for a couple of months as they abide by the rule calling for a **“communications blackout” period**. During this time, legislative offices cannot use official resources to send out general public updates like newsletters.



However, if you have questions for Senator Patterson, you may contact her office at (503) 986-1710 or Sen.DebPatterson@oregonlegislature.gov.

For Representative Evans, You are invited to contact his office anytime if you have questions or need assistance with state services. (503) 986-1420, Rep.PaulEvans@oregonlegislature.gov.



Official communications will resume once the blackout period ends.

Contents, April, 2026

March Happenings	1
Community Calendar	2, 3
Howl From the Heart	4
Farmers Markets Open	5
Polk Co Community Gift Card	5
The Thoughts & Gifts Project	5
MINET FIBER	5
Oddities Auction	6
MINET is 20!	7
Adopt-An-Artifact	7
Donate Oddities	7
Spectrum Artworx Calendar	8
City Newsletters++	8
About 2C1C	8
Climate Café	9
Imagine our Future Showcase	9
Nat'l Tartan Day	9
Blooms & Brunch	9
Territory Rest. Menu	10
Roots Open	10
National Gardening Day	10
Time Travel through Play	11
Wall That Heals honored	11
IDA Quarterly Meeting	12
Happening in Indy	12
Ind. Parking Meters	12
Maganda Glass	13
Friends/Library Book Sale	13
Be a Board Member	14
A Little Police History	14
Avina Health advice	14
Smith Fine Arts	14
Ash Creek Arts Center	15
Museum Speakers	16
Rotary Baby Shower	16
Quarterly Town Hall, Monmouth	16
Earth Day	16
About "Hair"	16
WOU/CHS Local Games	17
Mayor Office Hours	17
Pancake Breakfast	17
M-I Trolley	17
Tri-Tip Thursday at Brew	18
Golden Hop Specials	18
Nat'l Piñata Day	18
Draw at the Gallery	19
Polk Flea Market	19

Big Wod Day	19
Age Café	19
Community Craft Days	19
Daddy Daughter Dance	20
WOU Creative Arts	20
K Insurance Group	20
Monmouth Business Spotlight	21
Nat'l Bookmobile Day	21
Azucena's Cleaning	21
River Gallery shows	22
WOU & business	23
Adult Programs, Mon. Library	24
M-I Trolley accolades	24
Youth Programs, Mon. Library	24
Fam Jam, Fairgrounds	24
Music Jam Night	25
Something Rotten!	25
Children's Book Day	25
Support what you Love	25
Independence Library	26
Watercolor Paint 'n Sip	26
Rough Cut Vintage	26
About M-I Community Foundation	27
Elysium Botanicals	28
April Birthdays	28
Veteran's Chat	28
Veteran of the Month	28
YMCA Play/Purpose	29
Bingo at the Elks	29
Launch Mid-Valley	29
Call for Art, Monmouth	29
AARP Tax-Aide	30
Project Management	30
FYI, programs at Monmouth Senior Ctr	31
Ella Curran Food Bank	32
100 Years Ago this Mo.	33
WOU Wednesday	34
Coming Events (& local ads):	
Master Gardener Sale	35
Shine&Sparkle Cleaning	35
The Lost Virginity Tour	35
M-I Story Night	36
Last Day of School	36
TedX Mt. Hood	37
Smith Fine Arts	38
WOU 25-26 Events	38
Main St Ice Cream	38
Rookies Sports Tap	38
WOU Creative Arts	39
Mon. Garden Club Sale	39
Legislators' articles on hiatus	39
Index and Partners	40

Partners Featured, April 2026

AARP Tax Aide		Monmouth Business Association
American Legion Post 33		Monmouth Garden Club
Ash Creek Arts Center		Monmouth Independence Community Foundation
Avini Health		Monmouth Monthly
Azucena's Cleaning LLC		Monmouth Public Library
Brew Coffee & Tap House		Monmouth Senior Community Center
Casa Burrito		Monmouth-Independence Climate Group
Central High School Sports		Oregon Lions Club
Central Lions Club		Pentacle Theatre
Chemeketa Center for Business & Industry		Polk County Community Card
City of Independence		Polk County Market
City of Monmouth		Polk County Master Gardeners
Curves		Representative Paul Evans
Dry Town Tap Station		River City Briefs
Dutch Bros		River Gallery
Ella Curran Food Bank		Rookies Sports Tap
Elysium Botanicals Wines & Vineyard		Roots
Fam Jam		Rotary Club
FireHouse Crossfit		Rough Cut Vintage
Friends of the Independence Library		Senator Deb Patterson
Friends of the Monmouth Senior Center		Shine & Sparkle Cleaning Services
Golden Hop Saloon		Sing Fay
Grain Station Brew Works		Smith Fine Arts Series
Greece Lightning Express		Spectrum Artworx
Habanero's		Subway
Habebah Coffee & Cuisine		Sushi Roll 'n
Hazel's on Main		Tan Republic Monmouth
Heritage Museum		Ted-x Mt. Hood
Heritage Museum Society		Territory Restaurant
Heron Pointe Senior Living		The Find
Independence Downtown Association		The Original Independence Farmers Market
Independence Elks Lodge		The Sippery Coffee Co
Independence Public Library		The Thoughts & Gifts Project
Independence Riverview Market		The Wall That Heals
Indy Commons		Valkyrie Wine Tavern
K Insurance Group		Vibe & Thrive Esthetics
Koyotes Tacos		Western Oregon University
La Uvita Feliz		Western Oregon University Sports
Maganda Glassworks		Yang's Teriyaki
Main Street Ice Cream Parlor		Yeasty Beasty
MaMere's Guest House		YMCA
Mana		
Maui Melts		
M-I Green Bag Project		
M-I Trolley		
MINET Fiber		
Momiji		